

cx]ozoy'sohkF5'ryd8vp  
1 : 25

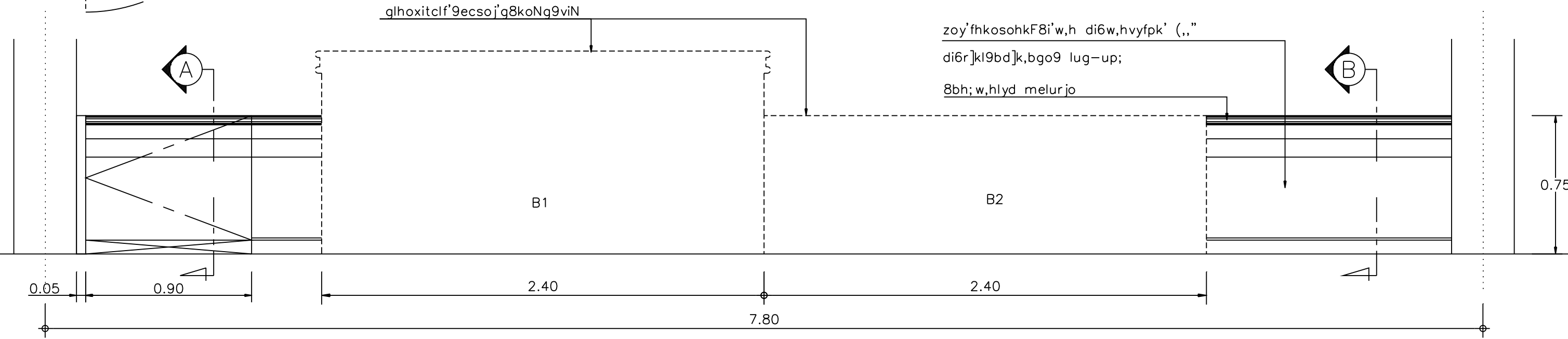

i^xfhkozoy'sohkF5'ryd8vp  
1 : 25

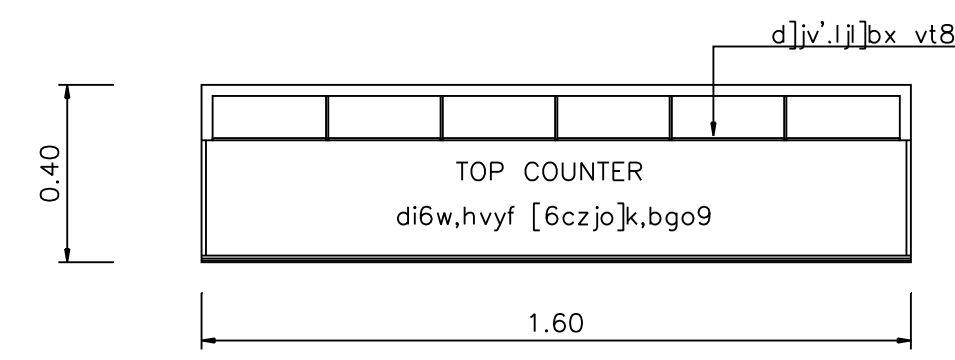

cx]og8koNg9viNg-upo.[ /kd35vo  
1 : 20

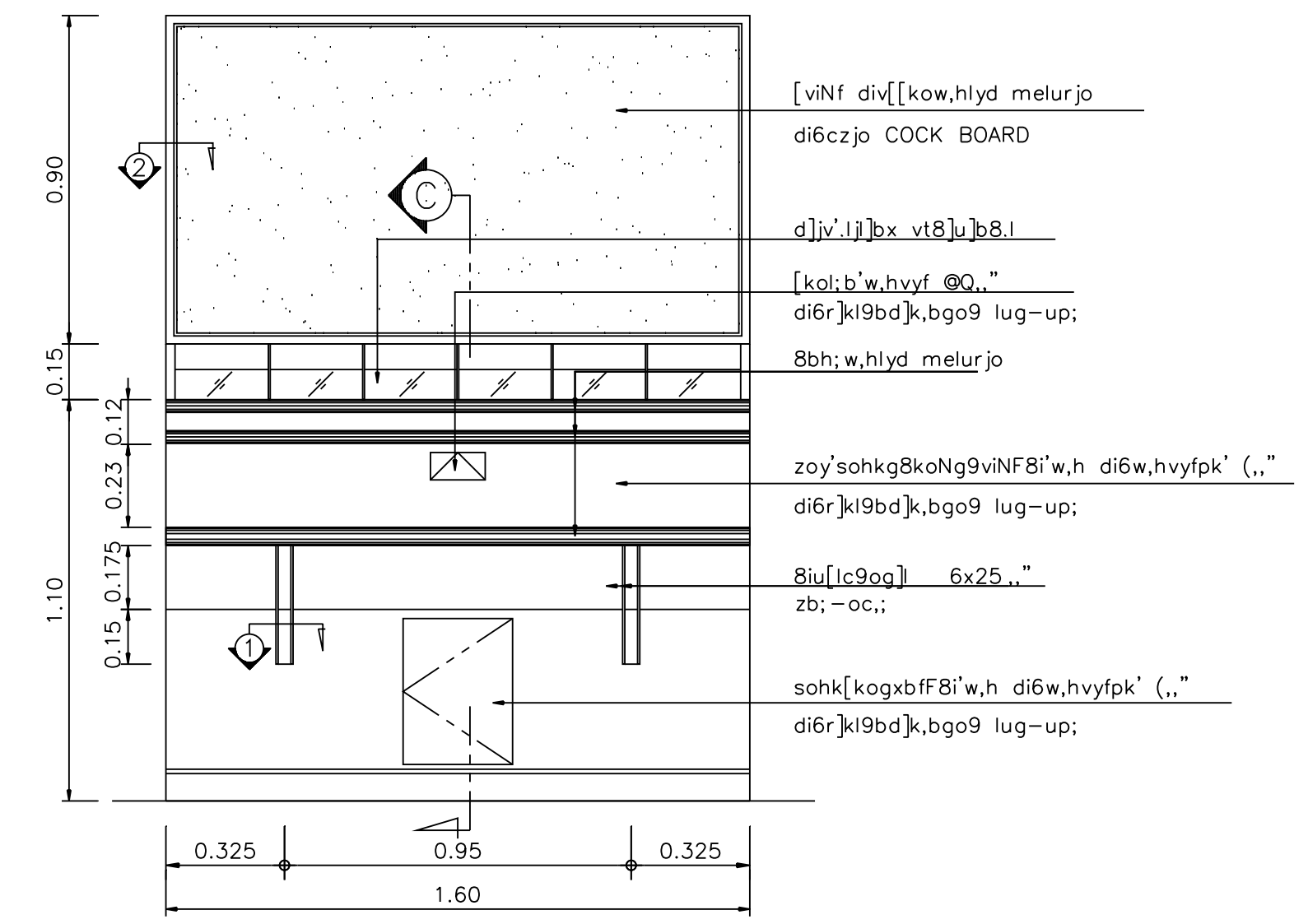

i^xfhko  
1 : 20

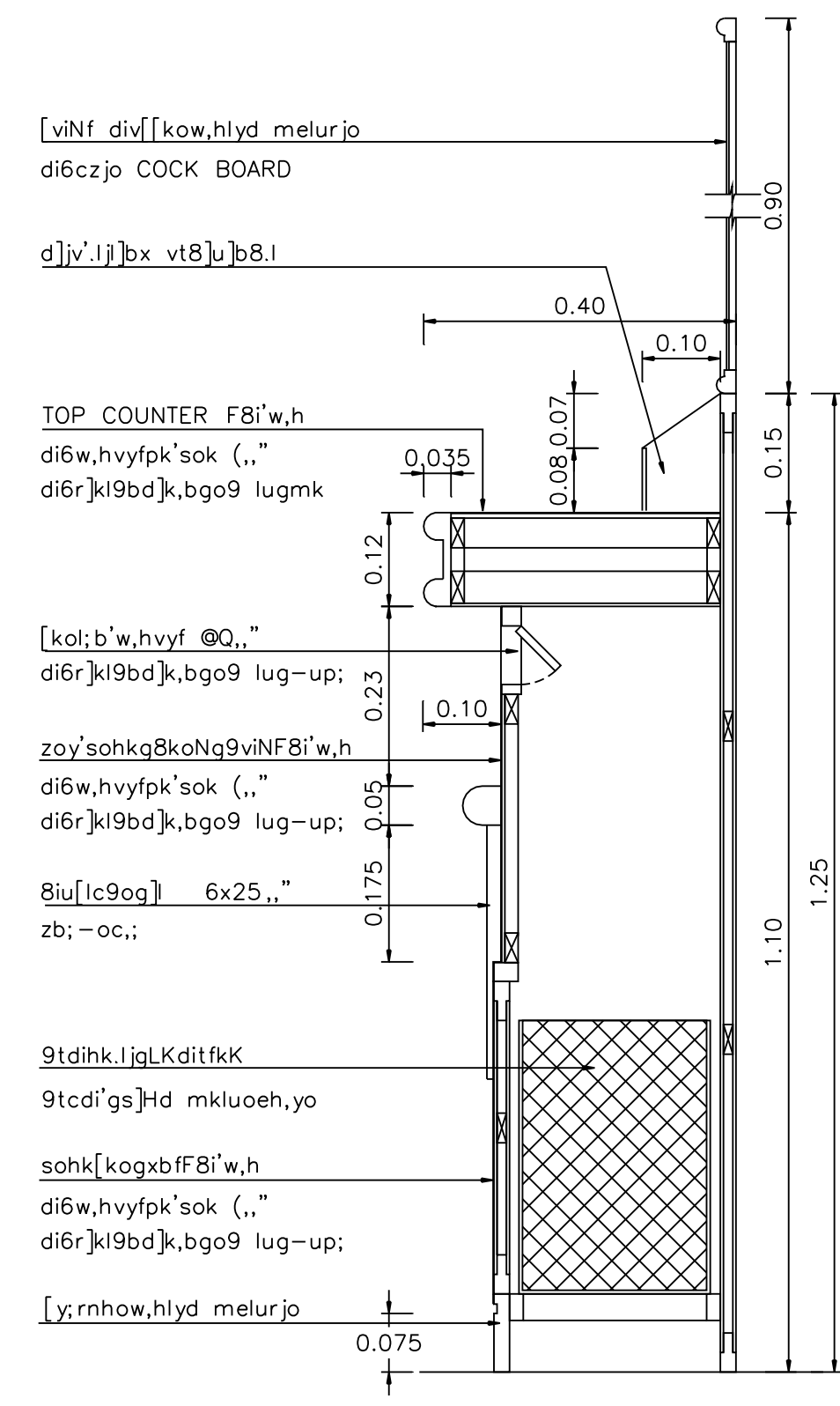

i^x9yf C  
1 : 10

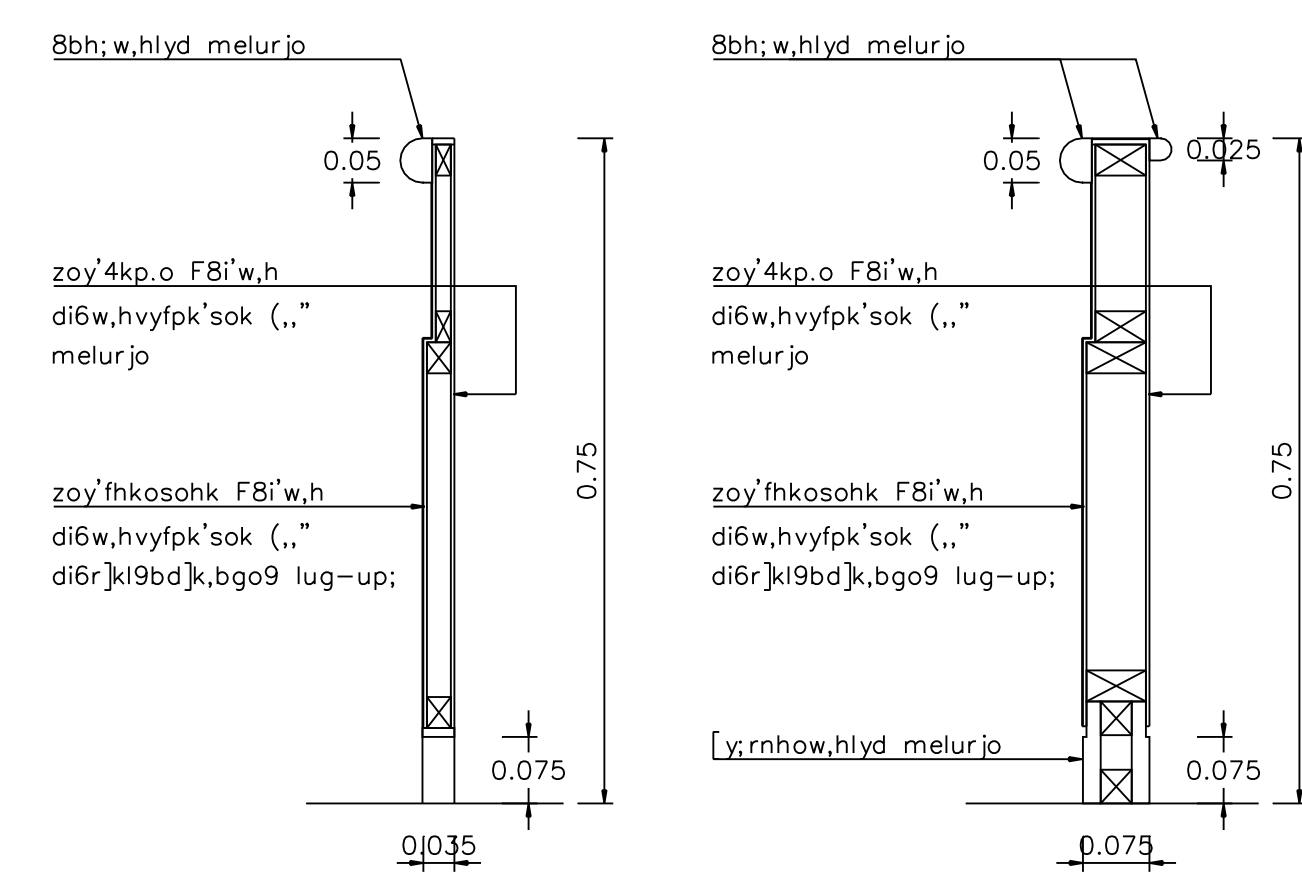

i^x9yf A  
1 : 10

i^x9yf B  
1 : 10

9b[kory[xit9^c[[i;b'gxbf #mk' 555CPS  
SERIES 04-4001CBS

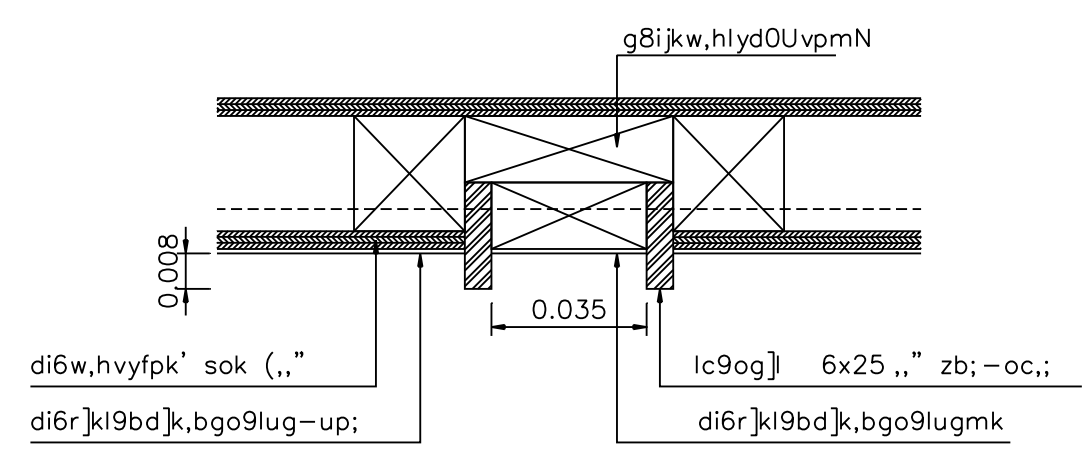

i^x9yf-pkp @  
1 : 2

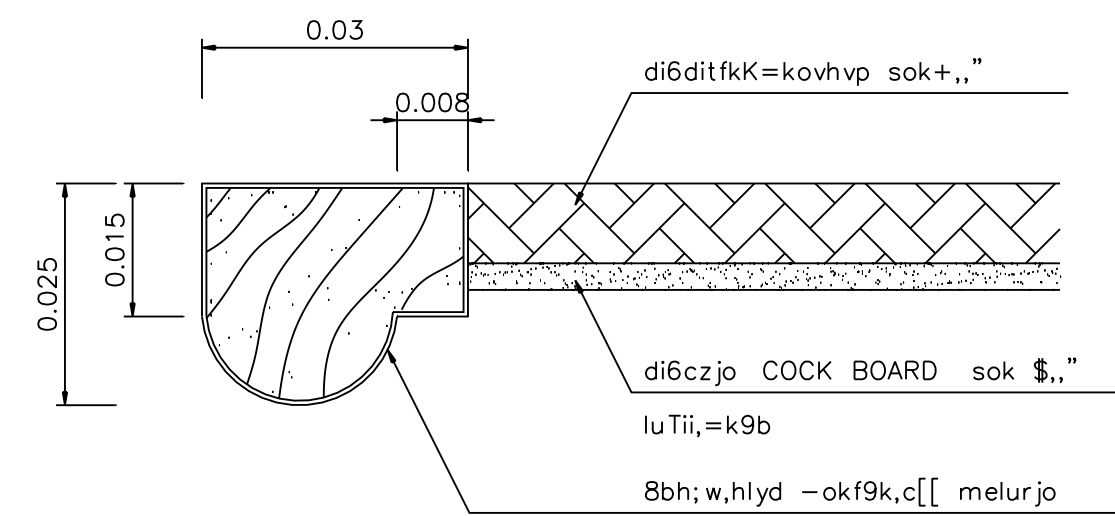

i^x9yf-pkp #  
1 : 1

REVISIONS	DATE
A c[[d]virk'	15/02/2000

NOTE  
 • ALL DIMENSIONS ARE IN METER UNLESS OTHERWISE INDICATED  
 • NO DIMENSION SHALL BE SCALED  
 • ALL DRAWINGS ARE THE PROPERTY OF THE AREA CO.,LTD. AND CAN NOT BE USED REPRODUCED OR DUPLICATED WITHOUT PERMISSION

OWNER  
 Tok8kigrn jvdkgidK9i  
 c]tsididkigqk9i

DESIGNER  
**AREA** AREA CO.,LTD.  
 111/1 Lodproo23 Lodoo Chaluchok Bangkok 10900  
 Tel. (662) 5139533-5 Fax. (662) 5139536

15kxobd  
 v]din 9ik=^ 15°000#  
 ;yo=yp [6P;ib=pN 15°0°#4  
 rie=yp d9b;ikilki 15°7°#4  
 ;b[ ]m g0bP;ik;6cb 15°000#

ASSISTANT ARCHITECT  
 gdup'wdi clo6;LN  
 ;bl; diF8i'lihk'  
 ;kot 0i^P^XNlydbN ip^20#  
 v]din 9ik=^ ip^3303  
 foyp i; kFC, ip^33^\_

;bl; diI6-k4b[k]  
 i64ymi ;ktb=pnd6] lod^0#\_  
 Lbib=yp 0yo9iud6] x; i'

;bl; diwaahk  
 [iio' g0bP000^]z] :od^0#  
 =yp; ycoN :nj9i' 4od^\*50%

;bl; dig8in jv'd  
 ly' ob9bro id^0%\_ \$

;yRokdi  
 ruil69 i6;idpt;bdpN 15°7°#04  
 lbtmT=yp v6joptryd9N [24kp.oX

DRAWN [tby9i s.y]lug]l  
 CHECKED

APPROVED

F8i'dki  
 vk8kileoyd'kolk-k

mu j9&'  
 v^ iirpk 0^ =ypokm

c[[clt'  
 c[[ -pkpzoys'ohkF5'ryd8vp  
 c[[ -pkp8koNg9viNg-upo.[ /kd35vo

FILE NO 9910	DRAWING NO A - 45
DATE 15 / 02 / 2000	
SUB TOTAL 45	GRAND TOTAL 93

Area-A2(roll) 390x600mm.

